

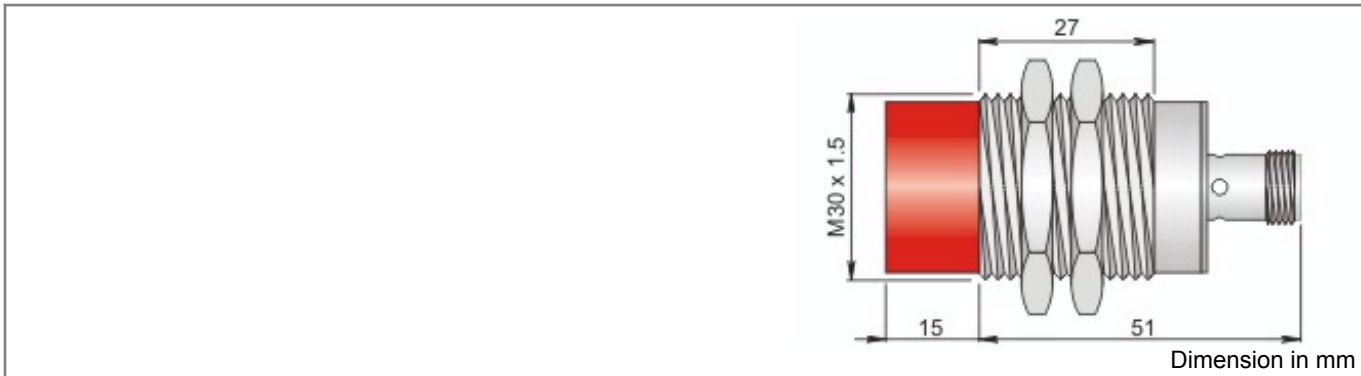

Part number: I30000128 - Model: SI30-NE15 H



TECHNICAL CHARACTERISTICS	
Power supply:	Direct current
Working voltage:	5 ÷ 30 Vdc
Switching distance (mm):	15
Max switching frequency:	500 Hz
Repeatability (%Sn):	< = 3
Absorption:	On < = 1 mA - Off >= 3 mA @ 8.2V
Temperature limits:	-25 ÷ +70 °C
IP rating:	Depending on connector
Housing material:	Nickelled brass
Mechanical characteristics:	M30x1.5
Connection type:	H plug
Weigth:	120 g



Part number: I30000128 - Model: SI30-NE15 H

WIRING DIAGRAM

CONNECTION WITH H PLUG

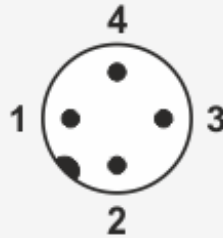
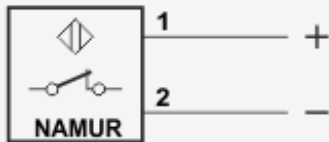

VIEW OF MALE CONNECTOR

1 = Brown / +
2 = Blue / -

INSTRUCTIONS FOR CORRECT INSTALLATION

INSTRUCTIONS FOR CORRECT INSTALLATION

NOT EMBEDDABLE

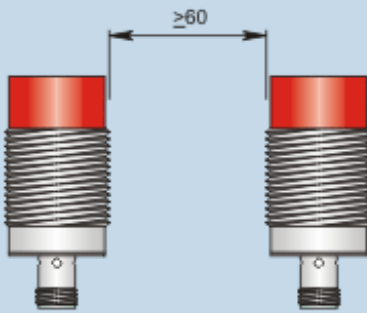

Side by side mounting

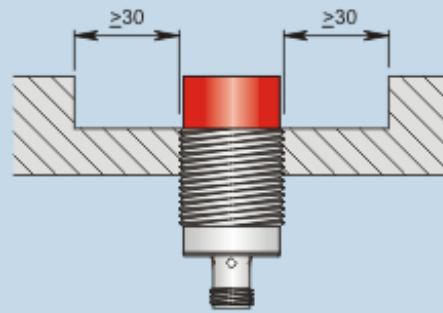

Non flush mounting

WORKING PRINCIPLE



Metallic plate



In presence of metal $I \leq 1 \text{ mA @ } 8.2 \text{ V}$

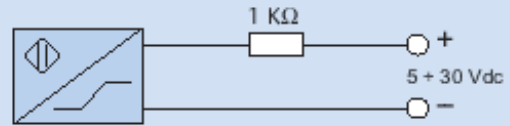

In absence of metal $I \geq 3 \text{ mA @ } 8.2 \text{ V}$

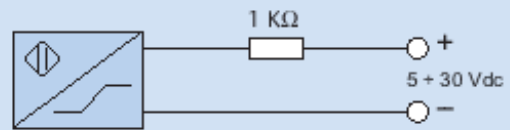

The NAMUR sensors are electronic devices whose absorbed current varies in the presence of a metallic object. The difference between these sensors and traditional sensors is the absence of amplifier trigger stages.